











36 210 740



- Drehumstellung
- ohne Rosette
- Griff Ø 60 mm

Passt zu: CL.1, META, CYO

| | | |
|--|---------------------------------|---------------|
|  | Chrom | 36 210 740-00 |
|  | Platin gebürstet | 36 210 740-06 |
|  | Light Gold | 36 210 740-26 |
|  | Light Gold gebürstet | 36 210 740-27 |
|  | Messing gebürstet (23kt Gold) | 36 210 740-28 |
|  | Schwarz matt | 36 210 740-33 |
|  | Bronze gebürstet | 36 210 740-42 |
|  | Champagne gebürstet (22kt Gold) | 36 210 740-46 |
|  | Champagne (22kt Gold) | 36 210 740-47 |
|  | Dark Platinum gebürstet | 36 210 740-99 |

Benötigtes Zubehör



- UP-Dreiwege-Umstellung -** 35 203 970 90
- Max. Einbautiefe 160 mm
 - Min. Einbautiefe 85 mm

36 210 740

mm [inches]

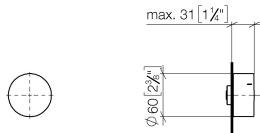

Durchflussdiagramm



Zertifikate

LGA_38380.

WRAS_2307045.

36 210 740

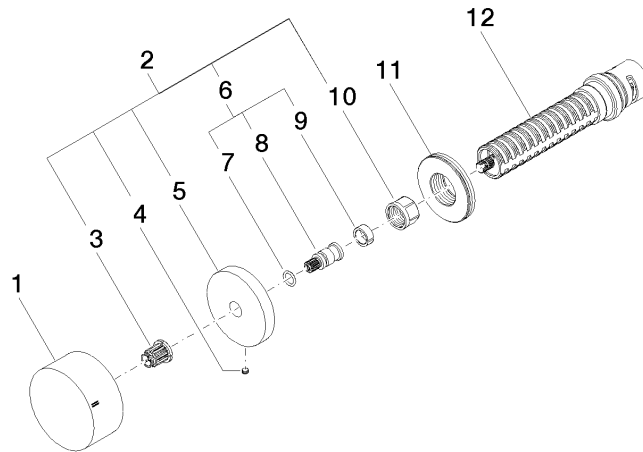

Ersatzteilstückliste

| Nr. | Artikelnummer | Benennung | Verbaumenge | Lieferzeit |
|-----|--------------------|------------|-------------|------------|
| 1 | 09 20 74 045-00 | Griff | 1 | 60 |
| 2 | 04 27 74 004 00-00 | Rosette | 1 | 10 |
| 3 | 90 12 12 002 00 90 | Rastbuchse | 1 | 2 |
| 4 | 09 31 11 055 90 | Stift | 1 | 2 |
| 5 | 09 27 74 004-00 | Rosette | 1 | 10 |
| 6 | 04 29 06 020 00-00 | Spindel | 1 | 10 |
| 7 | 90 14 10 060 00 90 | Dichtung | 1 | 2 |
| 8 | 09 29 06 020-00 | Spindel | 1 | 10 |
| 9 | 90 14 15 020 03 90 | Ring | 1 | 2 |
| 10 | 90 23 30 023 00 90 | Mutter | 1 | 2 |
| 11 | 09 30 01 107 90 | Huelse | 1 | 2 |
| 12 | 90 90 03 303 10 90 | Umstellung | 1 | 2 |